

No compromise on strength or safety.
Custom configurations are available across the range.

Each PORTA-GANTRY System Comprises:

- 2 x A-Frames (or custom alternatives)
- Beam lengths up to 9000mm (WLL dependent)
- Trolley - fully encapsulated for safety
NEW 2019
- Gated trolley - available on most options

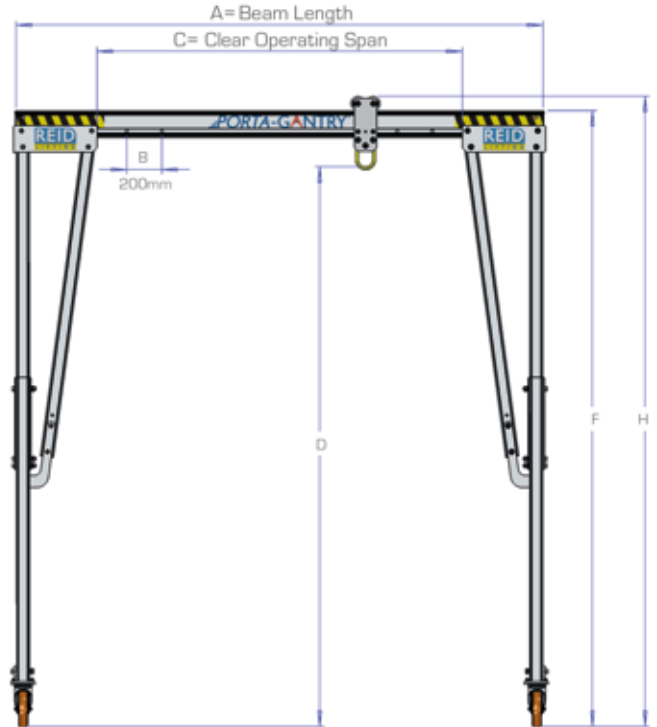
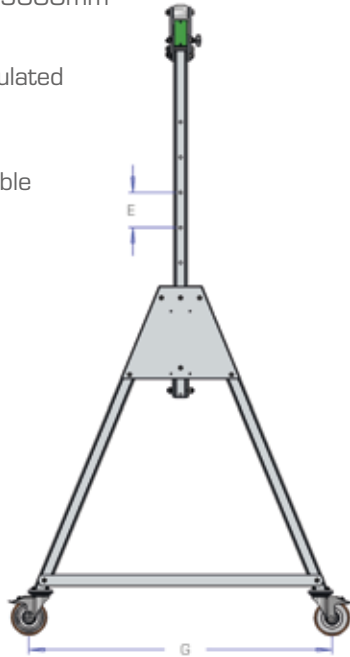

PORTA-GANTRY Beam Options































| | | Standard Beam Length A (mm) (Clear Operating Span C = A - 920 mm) | | | | | | | | A | C |
|----------------------|------|-------------------------------------------------------------------|------|------|------|------|------|------|------|---------------------------|---------------------------|
| | | 2500 | 3000 | 3920 | 4570 | 5500 | 6000 | 8400 | 9000 | Standard Beam Length (mm) | Clear Operating Span (mm) |
| WLL Rating (kg) | 500 | 19 | 22 | 29 | 34 | 41 | 44 | 62 | 66 | | |
| | 1000 | 19 | 22 | 29 | 34 | 41 | 44 | 79 | 84 | 2500 | 1580 |
| | 2000 | 19 | 22 | 29 | 34 | 52 | 93 | 130 | X | 3000 | 2080 |
| | 3000 | 19 | 22 | 37 | 43 | 85 | 93 | 130 | X | 3920 | 3000 |
| | 5000 | 39 | 47 | 61 | 71 | 85 | X | X | X | 4570 | 3650 |
| Weight of Beams (kg) | | | | | | | | | | 5500 | 4580 |
| | | | | | | | | | | 6000 | 5080 |



Beam Height Adjustment

The height of each gantry beam is easily adjusted by the release of 2 bolts on each upright and can be easily and safely raised into position by increments of 200 or 150mm. To assist with this activity a geared wheel or ratchet system is provided for the larger gantries; manual height adjustment on smaller frames.

PORTA-GANTRY Detailed Dimensions (mm)

| WLL (kg) | Frame size | D _{max} | E | | D _{min} | F | H _{max} | H _{min} | G | A-Frame Weight (kg) (approx.) | Trolley roller size | Castor Diam |
|---------------------------------------------------------------------------|-----------------------------------------------------------------------------------------------------------------------------------------------------------------------------------------------------------------------------------------------------------------------------------------------------------------------------------------------|---------------------------|------------------|-------------------------------------------------------------------------------------|---------------------------|---------------------------|-----------------------------|-----------------------------|-------|-------------------------------|---------------------|-------------|
| | | Max height to lifting eye | Height increment | | Min height to lifting eye | Max height to top of beam | Max height to top of roller | Min height to top of roller | Width | | | |
| 500 / 1000 | S | 2355 | 5 x 150 |  | 1605 | 2675 | 2757 | 2007 | 1212 | 29 | 82 | 150 |
| | M | 2851 | 5 x 150 |  | 2101 | 3171 | 3253 | 2503 | 1429 | 37 | 82 | 150 |
| | I | 3188 | 5 x 200 |  | 2188 | 3499 | 3581 | 2581 | 1726 | 45 | 82 | 200 |
| | T | 4079 | 6 x 200 |  | 2879 | 4399 | 4481 | 3281 | 2011 | 50 | 82 | 200 |
| | TC4 | 4527 | 6 x 200 |  | 3327 | 4847 | 4930 | 3730 | 2234 | 77 | 82 | 200 |
| | TC3 | 5027 | 6 x 200 |  | 3827 | 5347 | 5430 | 4230 | 2557 | 82 | 82 | 200 |
| | TC2 | 5527 | 8 x 200 |  | 3927 | 5848 | 5930 | 4330 | 2733 | 87 | 82 | 200 |
| | TC1 | 5829 | 9 x 200 |  | 4029 | 6149 | 6231 | 4431 | 2733 | 90 | 82 | 200 |
| 2000 | S | 2355 | 5 x 150 |  | 1605 | 2675 | 2757 | 2007 | 1212 | 32 | 82 | 150 |
| | M | 2851 | 5 x 150 |  | 2101 | 3171 | 3253 | 2503 | 1429 | 37 | 82 | 150 |
| | I | 3188 | 5 x 200 |  | 2188 | 3499 | 3581 | 2581 | 1726 | 45 | 82 | 200 |
| | T | 4079 | 6 x 200 |  | 2879 | 4399 | 4481 | 3281 | 2011 | 50 | 82 | 200 |
| | TC4 | 4527 | 6 x 200 |  | 3327 | 4847 | 4930 | 3730 | 2234 | 77 | 82 | 200 |
| | TC3 | 5027 | 6 x 200 |  | 3827 | 5347 | 5430 | 4230 | 2557 | 82 | 82 | 200 |
| | TC2 | 5527 | 8 x 200 |  | 3927 | 5848 | 5930 | 4330 | 2733 | 87 | 82 | 200 |
| | TC1 | 5829 | 9 x 200 |  | 4029 | 6149 | 6231 | 4431 | 2733 | 90 | 82 | 200 |
| 3000 | S | 2410 | 5 x 150 |  | 1660 | 2730 | 2812 | 2062 | 1212 | 48 | 82 | 200 |
| | M | 2906 | 5 x 150 |  | 2156 | 3226 | 3308 | 2558 | 1429 | 53 | 82 | 200 |
| | I | 3188 | 5 x 200 |  | 2188 | 3499 | 3581 | 2581 | 1726 | 66 | 82 | 200 |
| | T | 4079 | 6 x 200 |  | 2879 | 4399 | 4481 | 3281 | 2011 | 72 | 82 | 200 |
| | TC4 | 4527 | 6 x 200 |  | 3327 | 4847 | 4930 | 3730 | 2234 | 77 | 82 | 200 |
| | TC3 | 5027 | 6 x 200 |  | 3827 | 5347 | 5430 | 4230 | 2557 | 82 | 82 | 200 |
| | TC2 | 5527 | 8 x 200 |  | 3927 | 5848 | 5930 | 4330 | 2733 | 87 | 82 | 200 |
| 5000 | I | 3181 | 5 x 200 |  | 2181 | 3592 | 3717 | 2717 | 1736 | 88* | 125 | 200 |
| | T | 4049 | 6 x 200 |  | 2849 | 4487 | 4612 | 3412 | 2021 | 99* | 125 | 200 |
| | TC4 | 4500 | 6 x 200 |  | 3300 | 4938 | 5062 | 3862 | 2234 | 90 | 125 | 200 |
| | TC3 | 5000 | 6 x 200 |  | 3800 | 5438 | 5562 | 4362 | 2557 | 95 | 125 | 200 |
| | S & M versions also available as custom systems  = Manual  = Ratchet  = Geared | | | | | | | | | | | |
| WLL 5000kg dimensions systems are shown using the deeper 'D' section beam | | | | | | | | | | | | |

Dimensions use standard **Master Link Trolley**, other options available to increase resulting height of lift (HoL) and to assist with load movement.

*Weight includes stabiliser legs