

PORTA-GANTRY® RAPIDE 500-1000



Unique, ultra-light & rapidly deployable gantry that provides a versatile lifting solution for goods and personnel.



500 -1000KG
WLL



1-2
Person



33 - 42KG
Compact Storage



EN795

(S) = Small (M) = Medium (T) = Tall (see table)

The **PORTA-GANTRY RAPIDE** adds exciting new dimensions to the **PORTA-GANTRY** family.

A patented gantry that can be assembled in under 60 seconds for both goods and personnel lifting (man-ride) applications.

QUICK RELEASE PINS

Quick assembly with ball lock pins, no bolts or tools required

STOW'N'GO

A handy storage container for safe shipping and transportation (PGR 500 only)

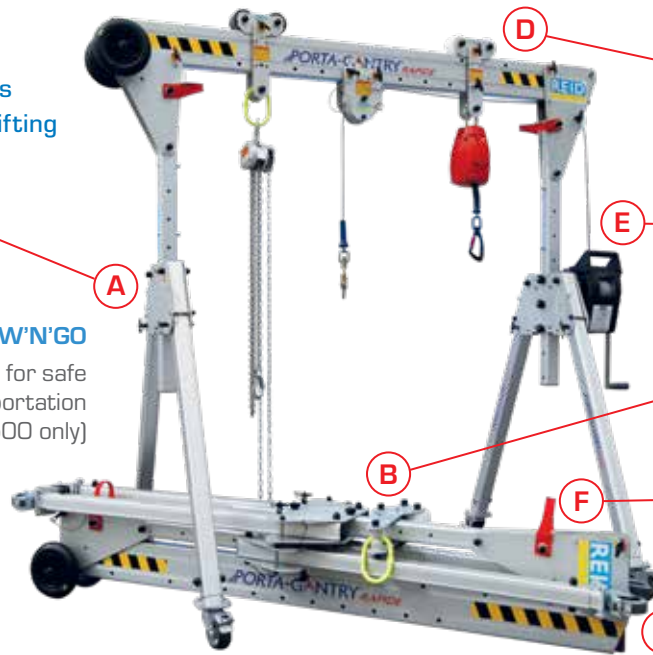

ASSEMBLY VIDEO

LOAD TROLLEY

Innovative quick release gated trolley or sheave carrier fitted in seconds

RAPID ATTACHMENTS

Winching accessories can be easily added without the need for tools

COMPACT

Frames easily fold onto beam, forming compact stowable unit. Easily fits into a typical service van

TRANSPORTABILITY

Easily transported by 1 person with integrated wheel and carry-handle or carried by 2 persons



PORTA-GANTRY RAPIDE 500-1000 Information:

- **GOODS WLL** Up to 1000kg
- **PERSONNEL WLL** Up to 500kg positioning depending on model, 150kg fall arrest
- **HEIGHT ADJUSTMENT** Range 500 to 900mm (see table)
- **3 PERSON FALL ARREST** In conformity with PD CEN/ TS16415:2013 (see table)
- **1 PERSON FALL ARREST** EN795:2012 certified - as part of an EN363 compliant system and in conformity with ANSI Z359.18-17* and AS/NZS 5532:2013
- **ROPE ACCESS** Conforms to IRATA International Code of Practice for industrial rope access
- **ATEX** All models suitable for use in ATEX Zone 2 explosive

- **atmospheres.** ATEX Zone 1 is available as an upgrade PGR 500 only
- **LIGHTWEIGHT & PORTABLE** Within manual handling guidelines, weighing from only 33kg for PGR500 and 42kg for PGR1000
- **CONFIGURATIONS** Range of beam lengths up to 4m and configurations available
- **GATED TROLLEY** Mounted in seconds, now with reduced head height
- **FOOTINGS** Height adjustable legs - 2 x 50mm adjustment on each leg with castors or levelling foot options
- **BEAM HOLES** Sheave carrier and Trolley lock off holes across the full length of the beam

* ANSI Z359.18-17 applies to 2m and 2.3m beams on PGR500 and full range of PGR1000

Patented & registered designs.



PORTA-GANTRY RAPIDE Dimensions (mm)

PGR

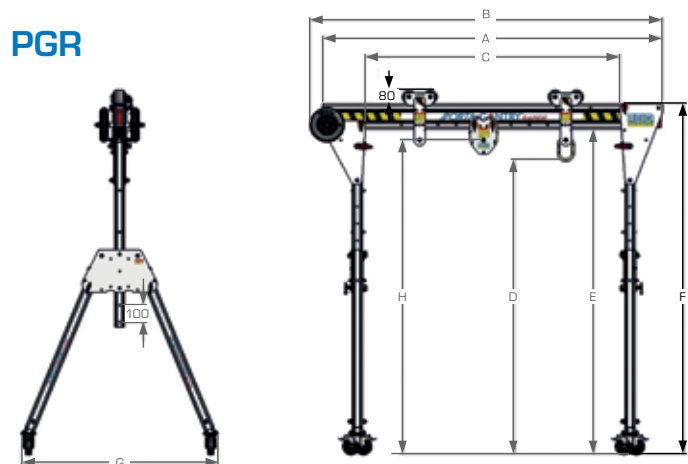

PGR1T

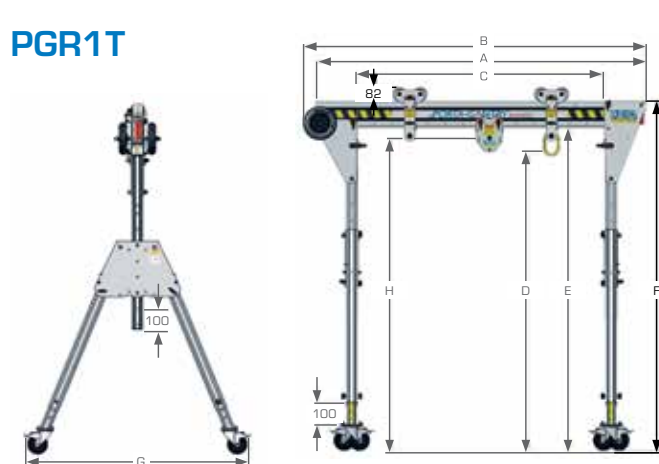

	Dimensions (mm)													WLL			Unit Weight				
	A Beam Length	B	C _{Min}	C _{Max}	D _{Min}	D _{Max}	E _{Min}	E _{Max}	F _{Min}	F _{Max}	G	H _{Min}	H _{Max}	J	Goods Capacity (kg)	Fall Arrest Capacity* No of Person(s)	Personnel Positioning* (kg)	(kg)			
PGRS20	2000	2076	1100	1500	1438	1938	1614	2114	1764	2264	1158	1550	2050	2190	500	3	250	33			
PGRS23	2300	2376	1200	1800										2376	400	2	200	35			
PGRS40	4000	4076	2700	3500										4076	250	1	125	40			
PGRM20	2000	2076	1100	1500	1442	2042	1618	2218	1768	2368	1215	1555	2155	2076	400	2	200	35			
PGRM23	2300	2376	1200	1800										2376				400	2	200	36
PGRM40	4000	4076	2700	3500										4076	400	2	200	41			
PGRT20	2000	2076	1100	1500	1916	2816	2092	2992	2242	3142	1586	2028	2928	2631	250	1	125	39			
PGRT23	2300	2376	1200	1800										2631				400	1	125	40
PGRT40	4000	4076	2700	3500										4076				400	1	125	45
PGR1TS20	2000	2077	1102	1502	1430	1930	1661	2161	1822	2322	1270	1549	2049	2077	1000	3	500	42			
PGR1TS30	3000	3077	1902	2502										3077	1000	3	500	50			
PGR1TS40	4000	4077	1902	3502										4077	1000	3	500	55			
PGR1TM20	2000	2077	1102	1502	1740	2440	1900	2600	2061	2761	1484	1859	2559	2200	1000	3	500	46			
PGR1TM30	3000	3077	1902	2502										3077	1000	3	500	51			
PGR1TM40	4000	4077	1902	3502										4077	1000	3	500	56			
PGR1TT20	2000	2077	1102	1502	1980	2880	2140	3040	2301	3201	1698	2099	2999	2830	1000	3	500	50			
PGR1TT30	3000	3077	1902	2502										3077	1000	3	500	55			
PGR1TT40	4000	4077	1902	3502										4077	1000	3	500	59			

*Ratings using European standards. Contact REID for other standards.