

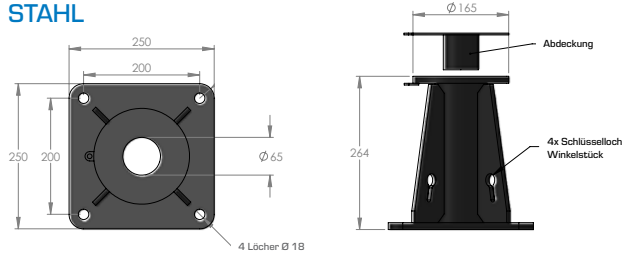

## SOCKEL ZEICHNUNGEN

### AUFBAU SOCKEL

STAHL



ALUMINIUM

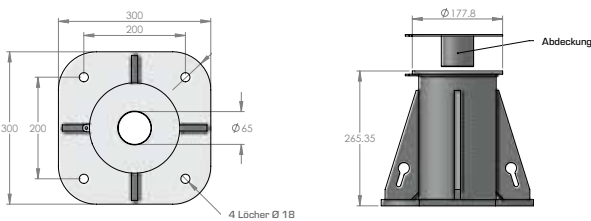

### SEITENANBAU

STAHL

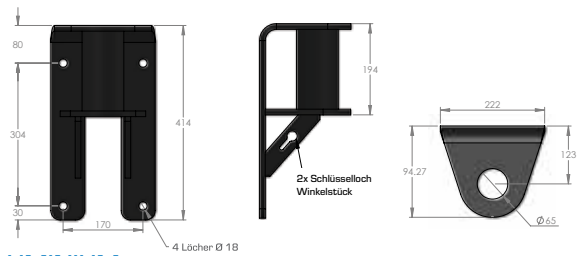

ALUMINIUM

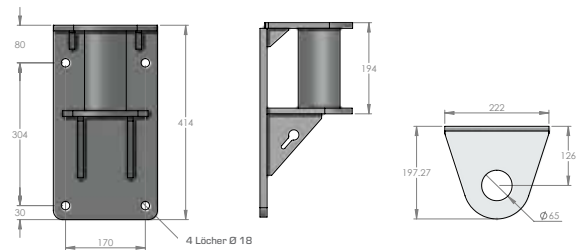

### BRÜCKENMONTAGE

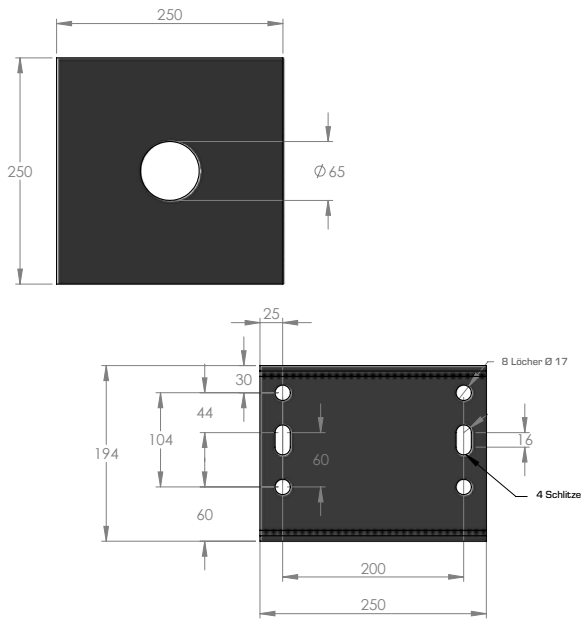

### “UNTER PUTZ” MONTAGE

EINGEGOSSEN

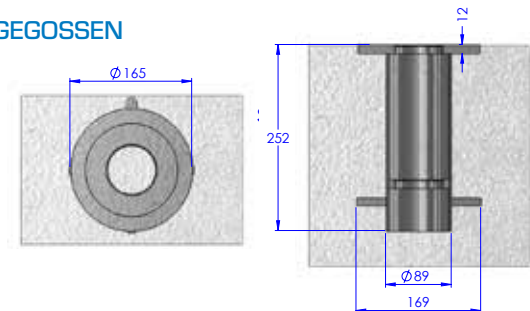

GIESSHARZ

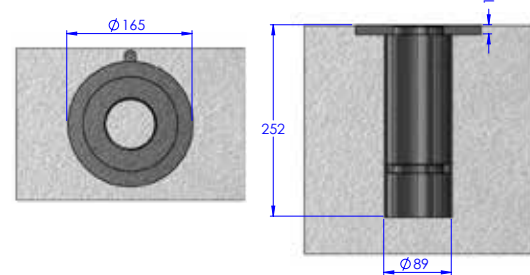

Sockel  
Verlängerungen

Der PORTA-DAVIT 500 wurde entwickelt um in alle bestehenden und neuen REID Lifting Sockel und Sockel Erweiterungen zu passen

Sockel

